

SHELVING UNITS



COMBO SHELVING
SQUARE BACK

SHELVING UNITS

SQUAREBACK COMBO UNITS / DIVIDERS AND BINS

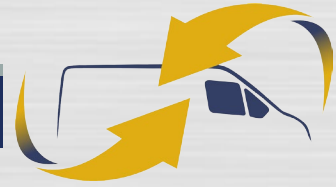

Our square back combo shelving modules are fabricated with 5052-H32 .100" thick aluminium. They are lightweight, strong and sturdy thanks to special aluminum alloys and advanced precision forging methods. Carefully designed with smart and functional features that are based upon 50 years of design, fabrication and installation experience. Our wide array of module dimensions makes it easy to satisfy your individual storage requirements.

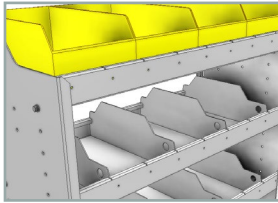

COST EFFICIENT. Our combo units offer a cost efficient solution by replacing the lower shelves with bin-like dividers.

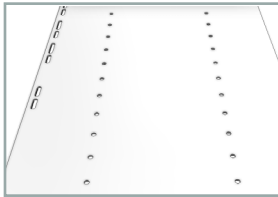

ADJUSTABLE. Our Side Panels are designed so you can adjust your shelves in 2" increments.

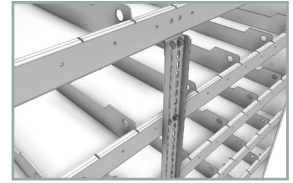
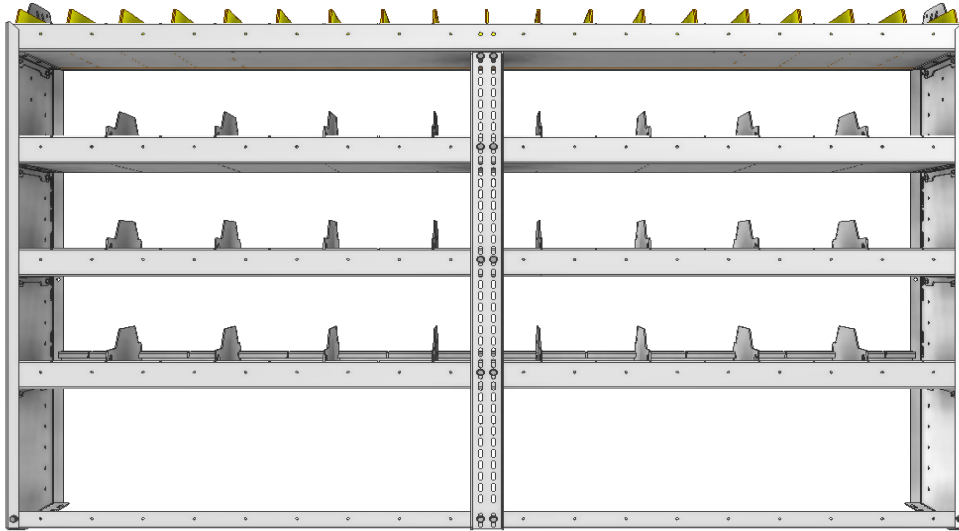

TOUGH. For added strength, our 72", 84" and 92" wide modules come with an adjustable mid support beam.

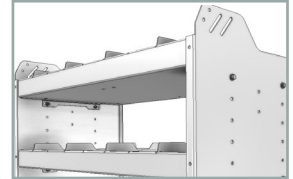

FLEXIBLE. Our shelving modules are designed to accommodate our unique backpanelling option.

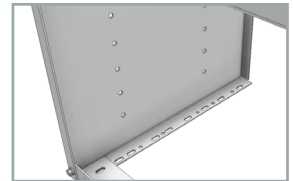

SMART. Our 1.5" lower lip design gives you extra room to use a powerdrill, and is designed to bolt down on the top of the floor's strengthening ribs.

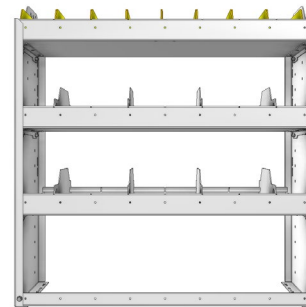
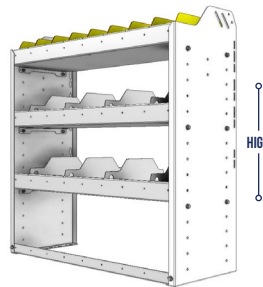
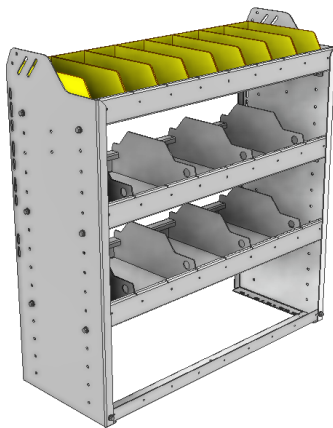

WIDE



DEEP

*18.5 deep combo unit only available with high dividers throughout

OPTIONS

PART NUMBER	DEEP (IN.)	WIDE (IN.)	HIGH (IN.)	STD SHELVES	HIGH DIVIDERS	STD BINS	WEIGHT (LBS.)	1 DOOR	BACK PANEL	STD SHELF	6 HIGH DIVIDERS	1 STD BIN	1 STD SHELF LINER
24-3136-3	11.5	34.5	36	3	8	5	39	DO-345	SQB-336	SBS-31	DV-611	SM-BIN	SBL-31
24-3136-4	11.5	34.5	36	4	12	5	47	DO-345	SQB-336	SBS-31	DV-611	SM-BIN	SBL-31
24-3336-3	13.5	34.5	36	3	8	8	47	DO-345	SQB-336	SBS-33	DV-613	MD-BIN	SBL-33
24-3336-4	13.5	34.5	36	4	12	8	56	DO-345	SQB-336	SBS-33	DV-613	MD-BIN	SBL-33
24-3536-3	15.5	34.5	36	3	8	4	52	DO-345	SQB-336	SBS-35	DV-615	LG-BIN	SBL-35
24-3536-4	15.5	34.5	36	4	12	4	62	DO-345	SQB-336	SBS-35	DV-615	LG-BIN	SBL-35
*24-3836-3	18.5	34.5	36	3	12	N / A	54	DO-345	SQB-336	SBS-38	DV-618	N / A	SBL-38
*24-3836-4	18.5	34.5	36	4	16	N / A	66	DO-345	SQB-336	SBS-38	DV-618	N / A	SBL-38

SHELVING UNITS

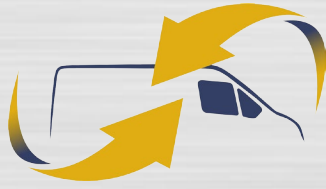

SQUAREBACK COMBO UNITS / DIVIDERS AND BINS

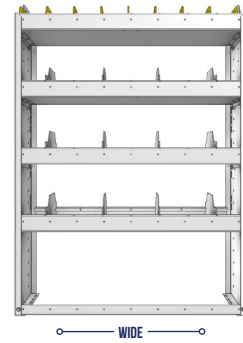
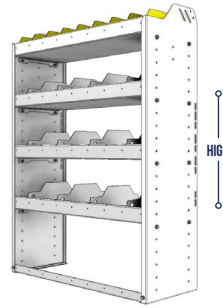
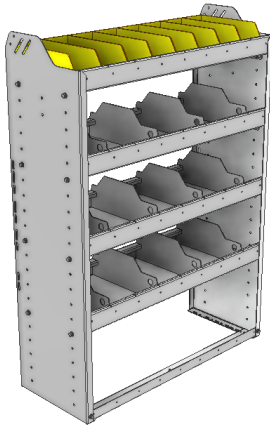

*18.5 deep combo unit only available with high dividers throughout

PART NUMBER	DEEP (IN.)	WIDE (IN.)	HIGH (IN.)	STD SHELVES	HIGH DIVIDERS	STD BINS	WEIGHT (LBS.)	OPTIONS					
								1 DOOR	BACK PANEL	STD SHELF	6 HIGH DIVIDERS	1 STD BIN	1 STD SHELF LINER
24-3148-3	11.5	34.5	48	3	8	5	42	DO-345	SQB-348	SBS-31	DV-611	SM-BIN	SBL-31
24-3148-4	11.5	34.5	48	4	12	5	50	DO-345	SQB-348	SBS-31	DV-611	SM-BIN	SBL-31
24-3348-3	13.5	34.5	48	3	8	8	50	DO-345	SQB-348	SBS-33	DV-613	MD-BIN	SBL-33
24-3348-4	13.5	34.5	48	4	12	8	59	DO-345	SQB-348	SBS-33	DV-613	MD-BIN	SBL-33
24-3548-3	15.5	34.5	48	3	8	4	56	DO-345	SQB-348	SBS-35	DV-615	LG-BIN	SBL-35
24-3548-4	15.5	34.5	48	4	12	4	66	DO-345	SQB-348	SBS-35	DV-615	LG-BIN	SBL-35
*24-3848-3	18.5	34.5	48	3	12	N/A	59	DO-345	SQB-348	SBS-38	DV-618	N/A	SBL-38
*24-3848-4	18.5	34.5	48	4	16	N/A	70	DO-345	SQB-348	SBS-38	DV-618	N/A	SBL-38

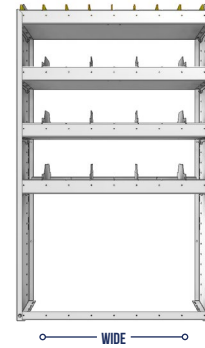
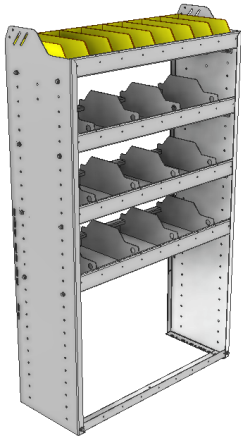

*18.5 deep combo unit only available with high dividers throughout

PART NUMBER	DEEP (IN.)	WIDE (IN.)	HIGH (IN.)	STD SHELVES	HIGH DIVIDERS	STD BINS	WEIGHT (LBS.)	OPTIONS					
								1 DOOR	BACK PANEL	STD SHELF	6 HIGH DIVIDERS	1 STD BIN	1 STD SHELF LINER
24-3158-3	11.5	34.5	58	3	8	5	45	DO-345	SQB-358	SBS-31	DV-611	SM-BIN	SBL-31
24-3158-4	11.5	34.5	58	4	12	5	53	DO-345	SQB-358	SBS-31	DV-611	SM-BIN	SBL-31
24-3358-3	13.5	34.5	58	3	8	8	53	DO-345	SQB-358	SBS-33	DV-613	MD-BIN	SBL-33
24-3358-4	13.5	34.5	58	4	12	8	62	DO-345	SQB-358	SBS-33	DV-613	MD-BIN	SBL-33
24-3558-3	15.5	34.5	58	3	8	4	60	DO-345	SQB-358	SBS-35	DV-615	LG-BIN	SBL-35
24-3558-4	15.5	34.5	58	4	12	4	70	DO-345	SQB-358	SBS-35	DV-615	LG-BIN	SBL-35
*24-3858-3	18.5	34.5	58	3	12	N/A	63	DO-345	SQB-358	SBS-38	DV-618	N/A	SBL-38
*24-3858-4	18.5	34.5	58	4	16	N/A	74	DO-345	SQB-358	SBS-38	DV-618	N/A	SBL-38

SHELVING UNITS

SQUAREBACK COMBO UNITS / DIVIDERS AND BINS

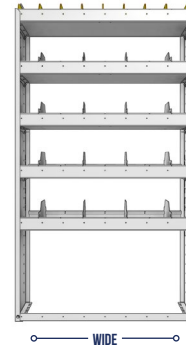
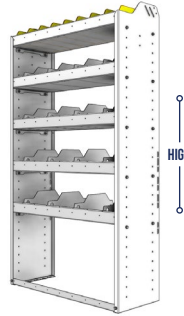
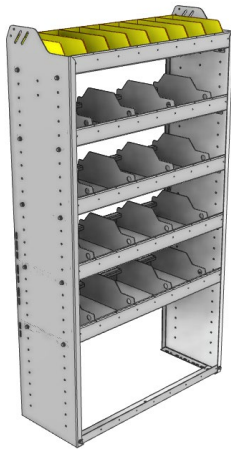
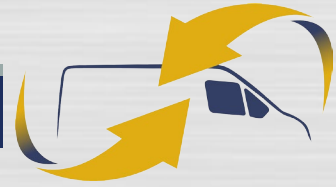

*18.5 deep combo unit only available with high dividers throughout

PART NUMBER	DEEP (IN.)	WIDE (IN.)	HIGH (IN.)	STD SHELVES	HIGH DIVIDERS	STD BINS	WEIGHT (LBS.)	OPTIONS					
								1 DOOR	BACK PANEL	STD SHELF	6 HIGH DIVIDERS	1 STD BIN	1 STD SHELF LINER
24-3163-4	11.5	34.5	63	4	12	5	54	DO-345	SQB-363	SBS-31	DV-611	SM-BIN	SBL-31
24-3163-5	11.5	34.5	63	5	16	5	62	DO-345	SQB-363	SBS-31	DV-611	SM-BIN	SBL-31
24-3363-4	13.5	34.5	63	4	12	8	64	DO-345	SQB-363	SBS-33	DV-613	MD-BIN	SBL-33
24-3363-5	13.5	34.5	63	5	16	8	73	DO-345	SQB-363	SBS-33	DV-613	MD-BIN	SBL-33
24-3563-4	15.5	34.5	63	4	12	4	71	DO-345	SQB-363	SBS-35	DV-615	LG-BIN	SBL-35
24-3563-5	15.5	34.5	63	5	16	4	81	DO-345	SQB-363	SBS-35	DV-615	LG-BIN	SBL-35
*24-3863-4	18.5	34.5	63	4	16	N / A	76	DO-345	SQB-363	SBS-38	DV-618	N / A	SBL-38
*24-3863-5	18.5	34.5	63	5	20	N / A	88	DO-345	SQB-363	SBS-38	DV-618	N / A	SBL-38

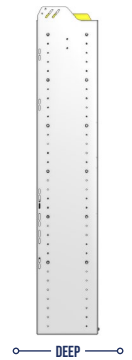
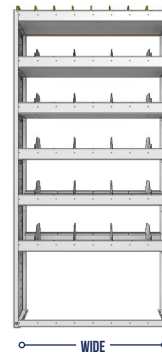
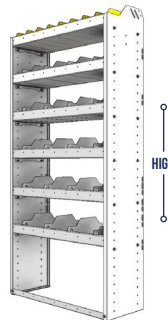
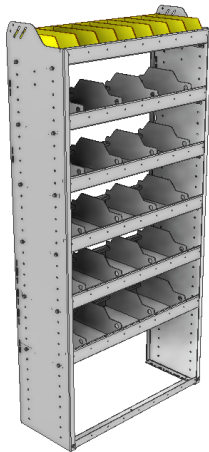

*18.5 deep combo unit only available with high dividers throughout

PART NUMBER	DEEP (IN.)	WIDE (IN.)	HIGH (IN.)	STD SHELVES	HIGH DIVIDERS	STD BINS	WEIGHT (LBS.)	OPTIONS					
								1 DOOR	BACK PANEL	STD SHELF	6 HIGH DIVIDERS	1 STD BIN	1 STD SHELF LINER
24-3172-5	11.5	34.5	72	5	16	5	64	DO-345	SQB-372	SBS-31	DV-611	SM-BIN	SBL-31
24-3172-6	11.5	34.5	72	6	20	5	72	DO-345	SQB-372	SBS-31	DV-611	SM-BIN	SBL-31
24-3372-5	13.5	34.5	72	5	16	8	76	DO-345	SQB-372	SBS-33	DV-613	MD-BIN	SBL-33
24-3372-6	13.5	34.5	72	6	20	8	85	DO-345	SQB-372	SBS-33	DV-613	MD-BIN	SBL-33
24-3572-5	15.5	34.5	72	5	16	4	84	DO-345	SQB-372	SBS-35	DV-615	LG-BIN	SBL-35
24-3572-6	15.5	34.5	72	6	20	4	94	DO-345	SQB-372	SBS-35	DV-615	LG-BIN	SBL-35
*24-3872-5	18.5	34.5	72	5	20	N / A	91	DO-345	SQB-372	SBS-38	DV-618	N / A	SBL-38
*24-3872-6	18.5	34.5	72	6	24	N / A	103	DO-345	SQB-372	SBS-38	DV-618	N / A	SBL-38

SHELVING UNITS

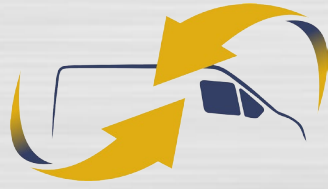

SQUARE BACK COMBO UNITS / DIVIDERS AND BINS

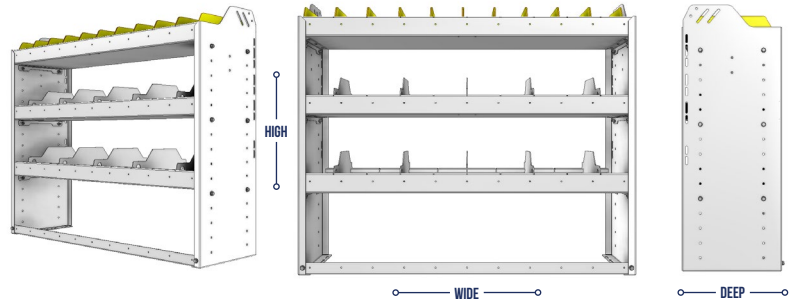
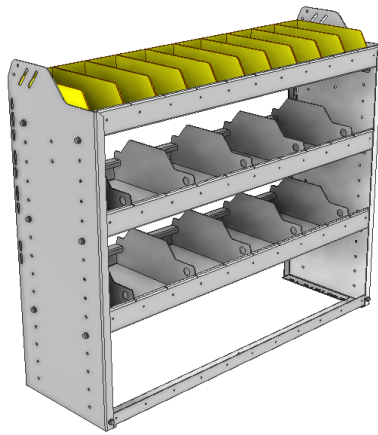

*18.5 deep combo unit only available with high dividers throughout

PART NUMBER	DEEP (IN.)	WIDE (IN.)	HIGH (IN.)	STD SHELVES	HIGH DIVIDERS	STD BINS	WEIGHT (LBS.)	OPTIONS					
								1 DOOR	BACK PANEL	STD SHELF	6 HIGH DIVIDERS	1 STD BIN	1 STD SHELF LINER
24-4136-3	11.5	43	36	3	10	7	46	DO-430	SQB-436	SBS-41	DV-611	SM-BIN	SBL-41
24-4136-4	11.5	43	36	4	15	7	56	DO-430	SQB-436	SBS-41	DV-611	SM-BIN	SBL-41
24-4336-3	13.5	43	36	3	10	10	54	DO-430	SQB-436	SBS-43	DV-613	MD-BIN	SBL-43
24-4336-4	13.5	43	36	4	15	10	66	DO-430	SQB-436	SBS-43	DV-613	MD-BIN	SBL-43
24-4536-3	15.5	43	36	3	10	5	61	DO-430	SQB-436	SBS-45	DV-615	LG-BIN	SBL-45
24-4536-4	15.5	43	36	4	15	5	73	DO-430	SQB-436	SBS-45	DV-615	LG-BIN	SBL-45
*24-4836-3	18.5	43	36	3	15	N / A	63	DO-430	SQB-436	SBS-48	DV-618	N / A	SBL-48
*24-4836-4	18.5	43	36	4	20	N / A	77	DO-430	SQB-436	SBS-48	DV-618	N / A	SBL-48

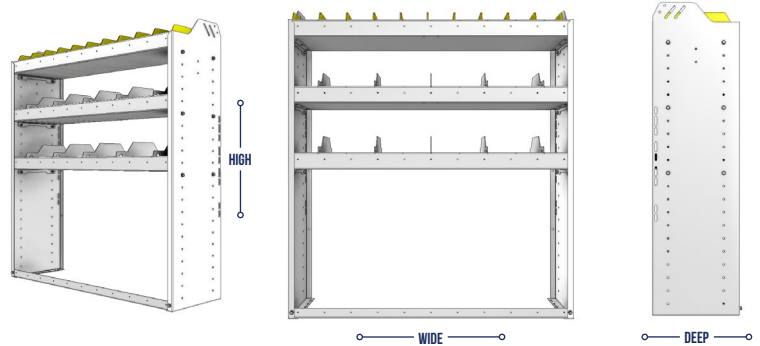
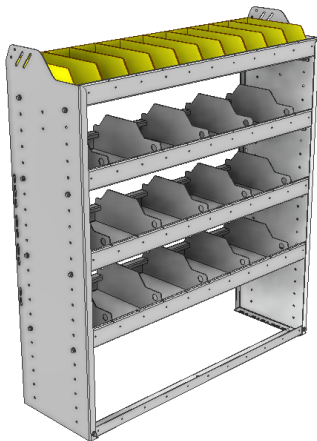

*18.5 deep combo unit only available with high dividers throughout

PART NUMBER	DEEP (IN.)	WIDE (IN.)	HIGH (IN.)	STD SHELVES	HIGH DIVIDERS	STD BINS	WEIGHT (LBS.)	OPTIONS					
								1 DOOR	BACK PANEL	STD SHELF	6 HIGH DIVIDERS	1 STD BIN	1 STD SHELF LINER
24-4148-3	11.5	43	48	3	10	7	49	DO-430	SQB-448	SBS-41	DV-611	SM-BIN	SBL-41
24-4148-4	11.5	43	48	4	15	7	59	DO-430	SQB-448	SBS-41	DV-611	SM-BIN	SBL-41
24-4348-3	13.5	43	48	3	10	10	58	DO-430	SQB-448	SBS-43	DV-613	MD-BIN	SBL-43
24-4348-4	13.5	43	48	4	15	10	69	DO-430	SQB-448	SBS-43	DV-613	MD-BIN	SBL-43
24-4548-3	15.5	43	48	3	10	5	65	DO-430	SQB-448	SBS-45	DV-615	LG-BIN	SBL-45
24-4548-4	15.5	43	48	4	15	5	77	DO-430	SQB-448	SBS-45	DV-615	LG-BIN	SBL-45
*24-4848-3	18.5	43	48	3	15	N / A	67	DO-430	SQB-448	SBS-48	DV-618	N / A	SBL-48
*24-4848-4	18.5	43	48	4	20	N / A	82	DO-430	SQB-448	SBS-48	DV-618	N / A	SBL-48

SHELVING UNITS

SQUAREBACK COMBO UNITS / DIVIDERS AND BINS

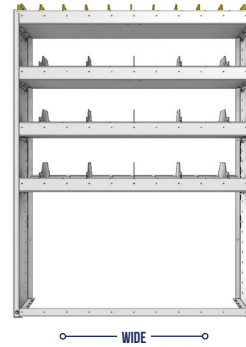
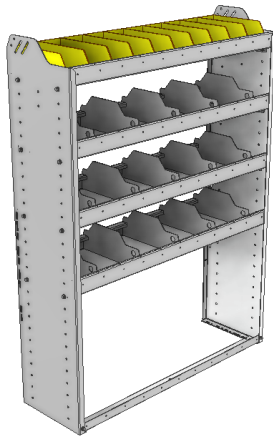
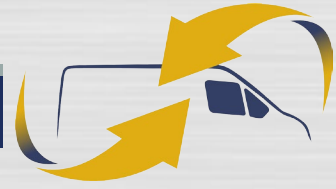

*18.5 deep combo unit only available with high dividers throughout

PART NUMBER	DEEP (IN.)	WIDE (IN.)	HIGH (IN.)	STD SHELVES	HIGH DIVIDERS	STD BINS	WEIGHT (LBS.)	OPTIONS					
								1 DOOR	BACK PANEL	STD SHELF	6 HIGH DIVIDERS	1 STD BIN	1 STD SHELF LINER
24-4158-3	11.5	43	58	3	10	7	51	DO-430	SQB-458	SBS-41	DV-611	SM-BIN	SBL-41
24-4158-4	11.5	43	58	4	15	7	61	DO-430	SQB-458	SBS-41	DV-611	SM-BIN	SBL-41
24-4358-3	13.5	43	58	3	10	10	61	DO-430	SQB-458	SBS-43	DV-613	MD-BIN	SBL-43
24-4358-4	13.5	43	58	4	15	10	72	DO-430	SQB-458	SBS-43	DV-613	MD-BIN	SBL-43
24-4558-3	15.5	43	58	3	10	5	68	DO-430	SQB-458	SBS-45	DV-615	LG-BIN	SBL-45
24-4558-4	15.5	43	58	4	15	5	81	DO-430	SQB-458	SBS-45	DV-615	LG-BIN	SBL-45
*24-4858-3	18.5	43	58	3	15	N / A	71	DO-430	SQB-458	SBS-48	DV-618	N / A	SBL-48
*24-4858-4	18.5	43	58	4	20	N / A	86	DO-430	SQB-458	SBS-48	DV-618	N / A	SBL-48

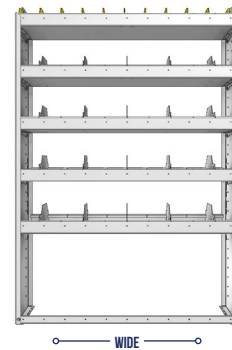
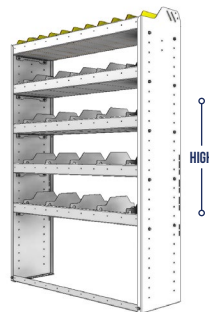
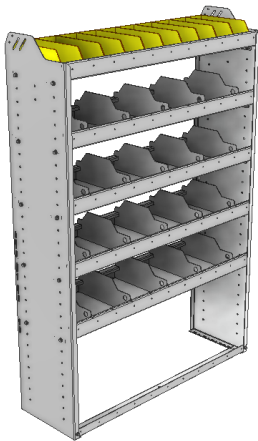

*18.5 deep combo unit only available with high dividers throughout

PART NUMBER	DEEP (IN.)	WIDE (IN.)	HIGH (IN.)	STD SHELVES	HIGH DIVIDERS	STD BINS	WEIGHT (LBS.)	OPTIONS					
								1 DOOR	BACK PANEL	STD SHELF	6 HIGH DIVIDERS	1 STD BIN	1 STD SHELF LINER
24-4163-4	11.5	43	63	4	15	7	62	DO-430	SQB-463	SBS-41	DV-611	SM-BIN	SBL-41
24-4163-5	11.5	43	63	5	20	7	72	DO-430	SQB-463	SBS-41	DV-611	SM-BIN	SBL-41
24-4363-4	13.5	43	63	4	15	10	74	DO-430	SQB-463	SBS-43	DV-613	MD-BIN	SBL-43
24-4363-5	13.5	43	63	5	20	10	85	DO-430	SQB-463	SBS-43	DV-613	MD-BIN	SBL-43
24-4563-4	15.5	43	63	4	15	5	82	DO-430	SQB-463	SBS-45	DV-615	LG-BIN	SBL-45
24-4563-5	15.5	43	63	5	20	5	95	DO-430	SQB-463	SBS-45	DV-615	LG-BIN	SBL-45
*24-4863-4	18.5	43	63	4	20	N / A	88	DO-430	SQB-463	SBS-48	DV-618	N / A	SBL-48
*24-4863-5	18.5	43	63	5	25	N / A	102	DO-430	SQB-463	SBS-48	DV-618	N / A	SBL-48

SHELVING UNITS

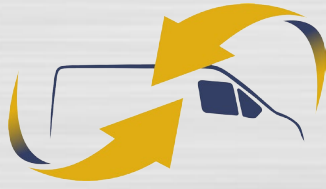

SQUARE BACK COMBO UNITS / DIVIDERS AND BINS

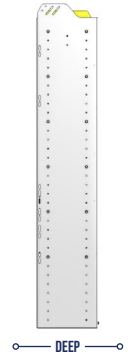
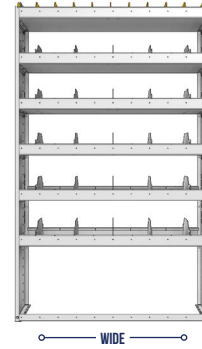
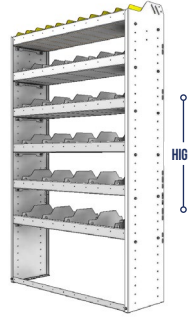
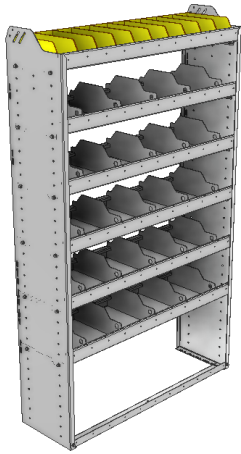

* 18.5 deep combo unit only available with high dividers throughout

PART NUMBER	DEEP (IN.)	WIDE (IN.)	HIGH (IN.)	STD SHELVES	HIGH DIVIDERS	STD BINS	WEIGHT (LBS.)	OPTIONS					
								1 DOOR	BACK PANEL	STD SHELF	6 HIGH DIVIDERS	1 STD BIN	1 STD SHELF LINER
24-4172-5	11.5	43	72	5	20	7	75	DO-430	SQB-472	SBS-41	DV-611	SM-BIN	SBL-41
24-4172-6	11.5	43	72	6	25	7	84	DO-430	SQB-472	SBS-41	DV-611	SM-BIN	SBL-41
24-4372-5	13.5	43	72	5	20	10	88	DO-430	SQB-472	SBS-43	DV-613	MD-BIN	SBL-43
24-4372-6	13.5	43	72	6	25	10	99	DO-430	SQB-472	SBS-43	DV-613	MD-BIN	SBL-43
24-4572-5	15.5	43	72	5	20	5	98	DO-430	SQB-472	SBS-45	DV-615	LG-BIN	SBL-45
24-4572-6	15.5	43	72	6	25	5	110	DO-430	SQB-472	SBS-45	DV-615	LG-BIN	SBL-45
*24-4872-5	18.5	43	72	5	25	N / A	106	DO-430	SQB-472	SBS-48	DV-618	N / A	SBL-48
*24-4872-6	18.5	43	72	6	30	N / A	120	DO-430	SQB-472	SBS-48	DV-618	N / A	SBL-48

SHELVING UNITS

SQUAREBACK COMBO UNITS / DIVIDERS AND BINS

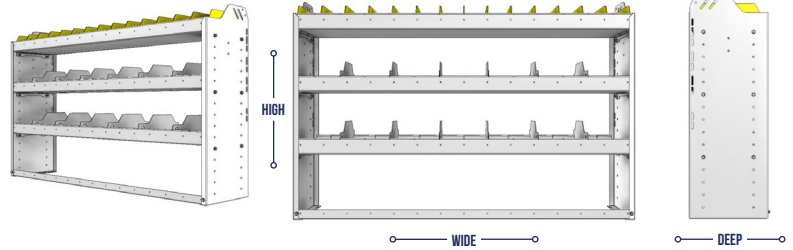
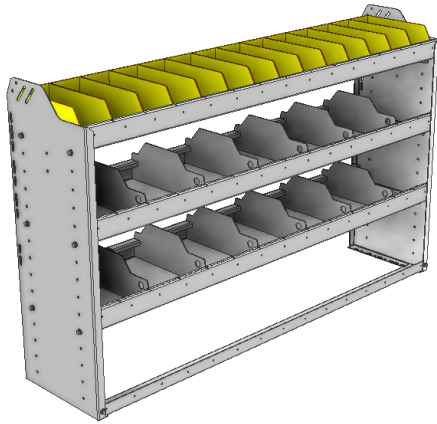
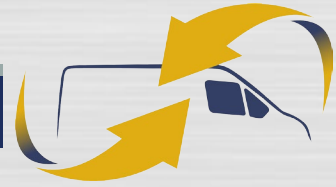

*18.5 deep combo unit only available with high dividers throughout

PART NUMBER	DEEP (IN.)	WIDE (IN.)	HIGH (IN.)	STD SHELVES	HIGH DIVIDERS	STD BINS	WEIGHT (LBS.)	OPTIONS					
								1 DOOR	BACK PANEL	STD SHELF	6 HIGH DIVIDERS	1 STD BIN	1 STD SHELF LINER
24-5136-3	11.5	59.94	36	3	12	9	56	DO-585	SQB-536	SBS-51	DV-611	SM-BIN	SBL-51
24-5136-4	11.5	59.94	36	4	18	9	69	DO-585	SQB-536	SBS-51	DV-611	SM-BIN	SBL-51
24-5336-3	13.5	59.94	36	3	12	14	68	DO-585	SQB-536	SBS-53	DV-613	MD-BIN	SBL-53
24-5336-4	13.5	59.94	36	4	18	14	83	DO-585	SQB-536	SBS-53	DV-613	MD-BIN	SBL-53
24-5536-3	15.5	59.94	36	3	12	7	76	DO-585	SQB-536	SBS-55	DV-615	LG-BIN	SBL-55
24-5536-4	15.5	59.94	36	4	18	7	93	DO-585	SQB-536	SBS-55	DV-615	LG-BIN	SBL-55
*24-5836-3	18.5	59.94	36	3	18	N/A	77	DO-585	SQB-536	SBS-58	DV-618	N/A	SBL-58
*24-5836-4	18.5	59.94	36	4	24	N/A	96	DO-585	SQB-536	SBS-58	DV-618	N/A	SBL-58

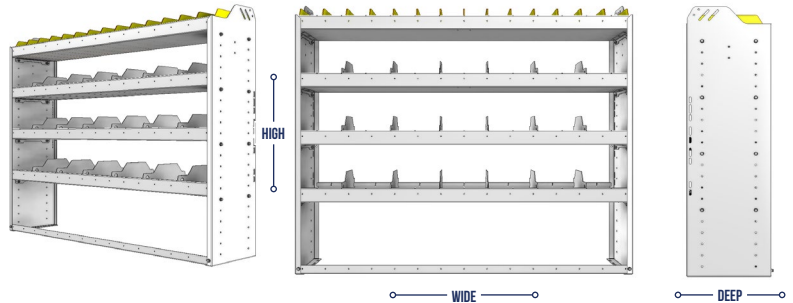
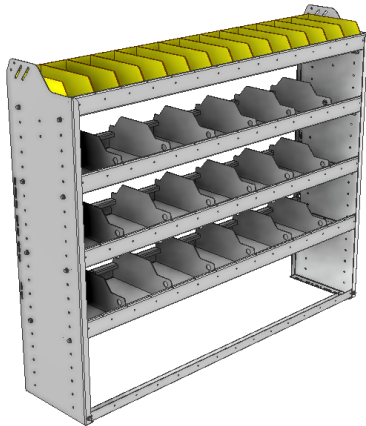

*18.5 deep combo unit only available with high dividers throughout

PART NUMBER	DEEP (IN.)	WIDE (IN.)	HIGH (IN.)	STD SHELVES	HIGH DIVIDERS	STD BINS	WEIGHT (LBS.)	OPTIONS					
								1 DOOR	BACK PANEL	STD SHELF	6 HIGH DIVIDERS	1 STD BIN	1 STD SHELF LINER
24-5148-3	11.5	59.94	48	3	12	9	59	DO-585	SQB-548	SBS-51	DV-611	SM-BIN	SBL-51
24-5148-4	11.5	59.94	48	4	18	9	72	DO-585	SQB-548	SBS-51	DV-611	SM-BIN	SBL-51
24-5348-3	13.5	59.94	48	3	12	14	71	DO-585	SQB-548	SBS-53	DV-613	MD-BIN	SBL-53
24-5348-4	13.5	59.94	48	4	18	14	86	DO-585	SQB-548	SBS-53	DV-613	MD-BIN	SBL-53
24-5548-3	15.5	59.94	48	3	12	7	80	DO-585	SQB-548	SBS-55	DV-615	LG-BIN	SBL-55
24-5548-4	15.5	59.94	48	4	18	7	97	DO-585	SQB-548	SBS-55	DV-615	LG-BIN	SBL-55
*24-5848-3	18.5	59.94	48	3	18	N/A	81	DO-585	SQB-548	SBS-58	DV-618	N/A	SBL-58
*24-5848-4	18.5	59.94	48	4	24	N/A	100	DO-585	SQB-548	SBS-58	DV-618	N/A	SBL-58

SHELVING UNITS

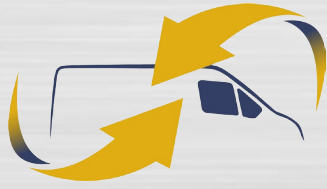

SQUARE BACK COMBO UNITS / DIVIDERS AND BINS

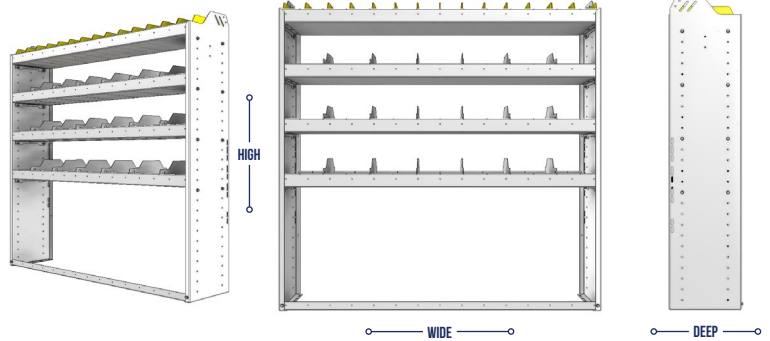
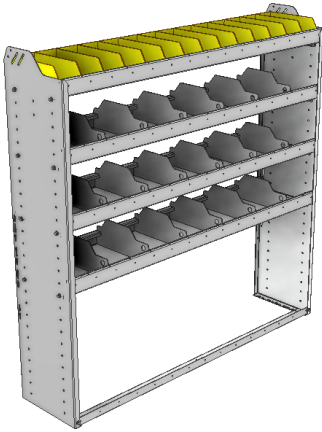

*18.5 deep combo unit only available with high dividers throughout

PART NUMBER	DEEP (IN.)	WIDE (IN.)	HIGH (IN.)	STD SHELVES	HIGH DIVIDERS	STD BINS	WEIGHT (LBS.)	OPTIONS					
								1 DOOR	BACK PANEL	STD SHELF	6 HIGH DIVIDERS	1 STD BIN	1 STD SHELF LINER
24-5158-3	11.5	59.94	58	3	12	9	62	DO-585	SQB-558	SBS-51	DV-611	SM-BIN	SBL-51
24-5158-4	11.5	59.94	58	4	18	9	75	DO-585	SQB-558	SBS-51	DV-611	SM-BIN	SBL-51
24-5358-3	13.5	59.94	58	3	12	14	74	DO-585	SQB-558	SBS-53	DV-613	MD-BIN	SBL-53
24-5358-4	13.5	59.94	58	4	18	14	89	DO-585	SQB-558	SBS-53	DV-613	MD-BIN	SBL-53
24-5558-3	15.5	59.94	58	3	12	7	84	DO-585	SQB-558	SBS-55	DV-615	LG-BIN	SBL-55
24-5558-4	15.5	59.94	58	4	18	7	100	DO-585	SQB-558	SBS-55	DV-615	LG-BIN	SBL-55
*24-5858-3	18.5	59.94	58	3	18	N/A	85	DO-585	SQB-558	SBS-58	DV-618	N/A	SBL-58
*24-5858-4	18.5	59.94	58	4	24	N/A	104	DO-585	SQB-558	SBS-58	DV-618	N/A	SBL-58

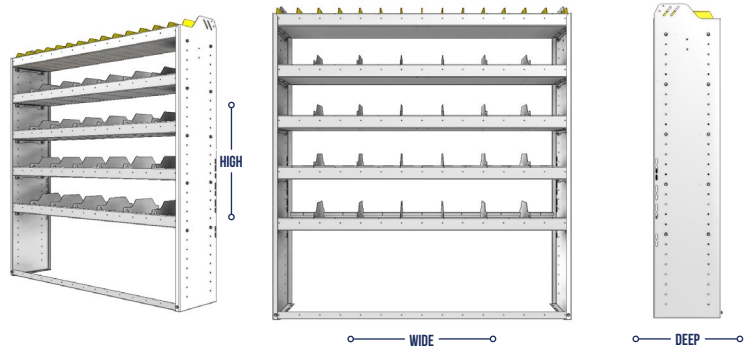
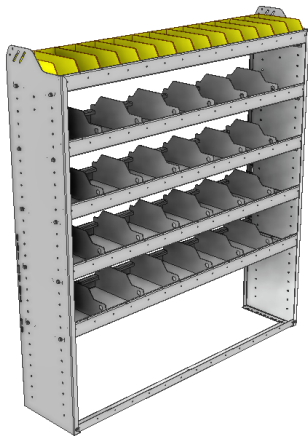

*18.5 deep combo unit only available with high dividers throughout

PART NUMBER	DEEP (IN.)	WIDE (IN.)	HIGH (IN.)	STD SHELVES	HIGH DIVIDERS	STD BINS	WEIGHT (LBS.)	OPTIONS					
								1 DOOR	BACK PANEL	STD SHELF	6 HIGH DIVIDERS	1 STD BIN	1 STD SHELF LINER
24-5163-4	11.5	59.94	63	4	18	9	76	DO-585	SQB-563	SBS-51	DV-611	SM-BIN	SBL-51
24-5163-5	11.5	59.94	63	5	24	9	89	DO-585	SQB-563	SBS-51	DV-611	SM-BIN	SBL-51
24-5363-4	13.5	59.94	63	4	18	14	91	DO-585	SQB-563	SBS-53	DV-613	MD-BIN	SBL-53
24-5363-5	13.5	59.94	63	5	24	14	106	DO-585	SQB-563	SBS-53	DV-613	MD-BIN	SBL-53
24-5563-4	15.5	59.94	63	4	18	7	101	DO-585	SQB-563	SBS-55	DV-615	LG-BIN	SBL-55
24-5563-5	15.5	59.94	63	5	24	7	118	DO-585	SQB-563	SBS-55	DV-615	LG-BIN	SBL-55
*24-5863-4	18.5	59.94	63	4	24	N/A	106	DO-585	SQB-563	SBS-58	DV-618	N/A	SBL-58
*24-5863-5	18.5	59.94	63	5	30	N/A	125	DO-585	SQB-563	SBS-58	DV-618	N/A	SBL-58

SHELVING UNITS

SQUAREBACK COMBO UNITS / DIVIDERS AND BINS

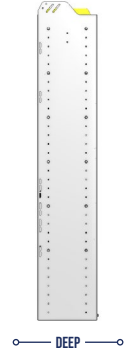
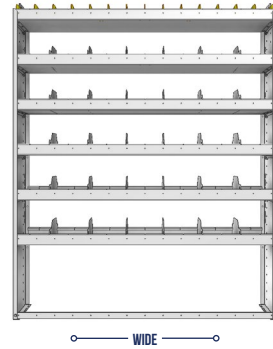
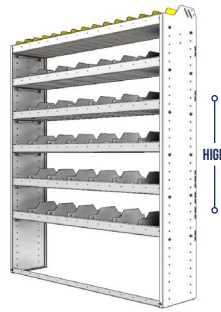
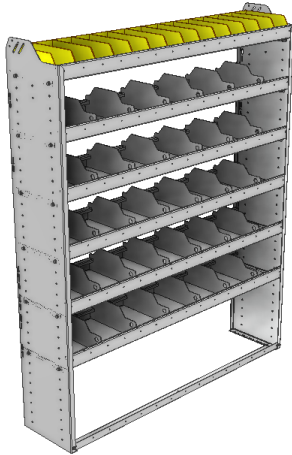

* 18.5 deep combo unit only available with high dividers throughout

PART NUMBER	DEEP (IN.)	WIDE (IN.)	HIGH (IN.)	STD SHELVES	HIGH DIVIDERS	STD BINS	WEIGHT (LBS.)	OPTIONS					
								1 DOOR	BACK PANEL	STD SHELF	6 HIGH DIVIDERS	1 STD BIN	1 STD SHELF LINER
24-5172-5	11.5	59.94	72	5	24	9	91	DO-585	SQB-572	SBS-51	DV-611	SM-BIN	SBL-51
24-5172-6	11.5	59.94	72	6	30	9	104	DO-585	SQB-572	SBS-51	DV-611	SM-BIN	SBL-51
24-5372-5	13.5	59.94	72	5	24	14	108	DO-585	SQB-572	SBS-53	DV-613	MD-BIN	SBL-53
24-5372-6	13.5	59.94	72	6	30	14	123	DO-585	SQB-572	SBS-53	DV-613	MD-BIN	SBL-53
24-5572-5	15.5	59.94	72	5	24	7	121	DO-585	SQB-572	SBS-55	DV-615	LG-BIN	SBL-55
24-5572-6	15.5	59.94	72	6	30	7	137	DO-585	SQB-572	SBS-55	DV-615	LG-BIN	SBL-55
*24-5872-5	18.5	59.94	72	5	30	N / A	128	DO-585	SQB-572	SBS-58	DV-618	N / A	SBL-58
*24-5872-6	18.5	59.94	72	6	36	N / A	147	DO-585	SQB-572	SBS-58	DV-618	N / A	SBL-58

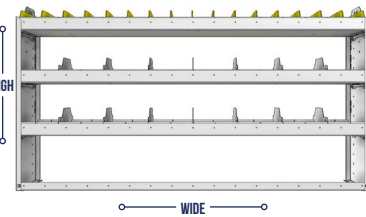
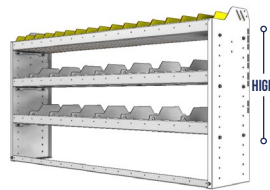
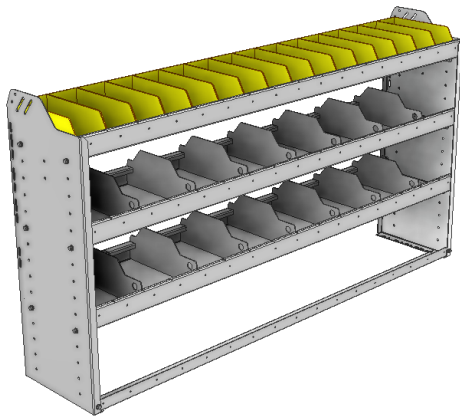

* 18.5 deep combo unit only available with high dividers throughout

PART NUMBER	DEEP (IN.)	WIDE (IN.)	HIGH (IN.)	STD SHELVES	HIGH DIVIDERS	STD BINS	WEIGHT (LBS.)	OPTIONS					
								1 DOOR	BACK PANEL	STD SHELF	6 HIGH DIVIDERS	1 STD BIN	1 STD SHELF LINER
24-6136-3	11.5	69.13	36	3	14	11	63	DO-670	SQB-636	SBS-61	DV-611	SM-BIN	SBL-61
24-6136-4	11.5	69.13	36	4	21	11	77	DO-670	SQB-636	SBS-61	DV-611	SM-BIN	SBL-61
24-6336-3	13.5	69.13	36	3	14	16	76	DO-670	SQB-636	SBS-63	DV-613	MD-BIN	SBL-63
24-6336-4	13.5	69.13	36	4	21	16	93	DO-670	SQB-636	SBS-63	DV-613	MD-BIN	SBL-63
24-6536-3	15.5	69.13	36	3	14	8	85	DO-670	SQB-636	SBS-65	DV-615	LG-BIN	SBL-65
24-6536-4	15.5	69.13	36	4	21	8	104	DO-670	SQB-636	SBS-65	DV-615	LG-BIN	SBL-65
*24-6836-3	18.5	69.13	36	3	21	N / A	85	DO-670	SQB-636	SBS-68	DV-618	N / A	SBL-68
*24-6836-4	18.5	69.13	36	4	28	N / A	107	DO-670	SQB-636	SBS-68	DV-618	N / A	SBL-68

SHELVING UNITS

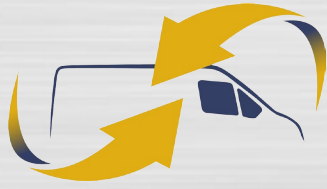

SQUARE BACK COMBO UNITS / DIVIDERS AND BINS

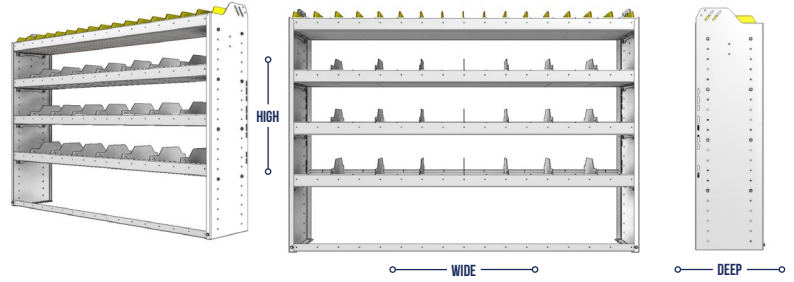
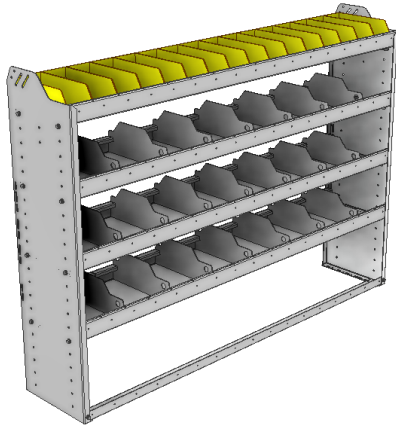

* 18.5 deep combo unit only available with high dividers throughout

PART NUMBER	DEEP (IN.)	WIDE (IN.)	HIGH (IN.)	STD SHELVES	HIGH DIVIDERS	STD BINS	WEIGHT (LBS.)	OPTIONS					
								1 DOOR	BACK PANEL	STD SHELF	6 HIGH DIVIDERS	1 STD BIN	1 STD SHELF LINER
24-6148-3	11.5	69.13	48	3	14	11	66	DO-670	SQB-648	SBS-61	DV-611	SM-BIN	SBL-61
24-6148-4	11.5	69.13	48	4	21	11	80	DO-670	SQB-648	SBS-61	DV-611	SM-BIN	SBL-61
24-6348-3	13.5	69.13	48	3	14	16	79	DO-670	SQB-648	SBS-63	DV-613	MD-BIN	SBL-63
24-6348-4	13.5	69.13	48	4	21	16	96	DO-670	SQB-648	SBS-63	DV-613	MD-BIN	SBL-63
24-6548-3	15.5	69.13	48	3	14	8	89	DO-670	SQB-648	SBS-65	DV-615	LG-BIN	SBL-65
24-6548-4	15.5	69.13	48	4	21	8	108	DO-670	SQB-648	SBS-65	DV-615	LG-BIN	SBL-65
*24-6848-3	18.5	69.13	48	3	21	N / A	90	DO-670	SQB-648	SBS-68	DV-618	N / A	SBL-68
*24-6848-4	18.5	69.13	48	4	28	N / A	112	DO-670	SQB-648	SBS-68	DV-618	N / A	SBL-68

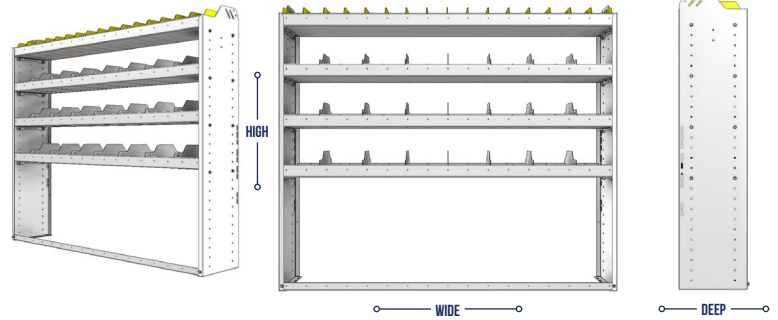
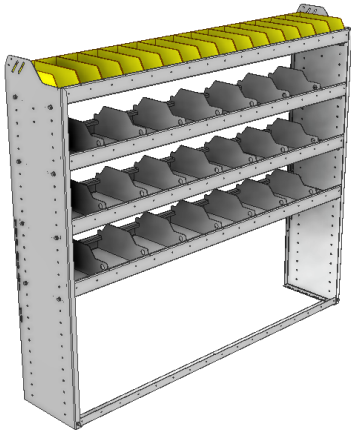

* 18.5 deep combo unit only available with high dividers throughout

PART NUMBER	DEEP (IN.)	WIDE (IN.)	HIGH (IN.)	STD SHELVES	HIGH DIVIDERS	STD BINS	WEIGHT (LBS.)	OPTIONS					
								1 DOOR	BACK PANEL	STD SHELF	6 HIGH DIVIDERS	1 STD BIN	1 STD SHELF LINER
24-6158-3	11.5	69.13	58	3	14	11	68	DO-670	SQB-658	SBS-61	DV-611	SM-BIN	SBL-61
24-6158-4	11.5	69.13	58	4	21	11	83	DO-670	SQB-658	SBS-61	DV-611	SM-BIN	SBL-61
24-6358-3	13.5	69.13	58	3	14	16	82	DO-670	SQB-658	SBS-63	DV-613	MD-BIN	SBL-63
24-6358-4	13.5	69.13	58	4	21	16	99	DO-670	SQB-658	SBS-63	DV-613	MD-BIN	SBL-63
24-6558-3	15.5	69.13	58	3	14	8	92	DO-670	SQB-658	SBS-65	DV-615	LG-BIN	SBL-65
24-6558-4	15.5	69.13	58	4	21	8	111	DO-670	SQB-658	SBS-65	DV-615	LG-BIN	SBL-65
*24-6858-3	18.5	69.13	58	3	21	N / A	94	DO-670	SQB-658	SBS-68	DV-618	N / A	SBL-68
*24-6858-4	18.5	69.13	58	4	28	N / A	116	DO-670	SQB-658	SBS-68	DV-618	N / A	SBL-68

SHELVING UNITS

SQUAREBACK COMBO UNITS / DIVIDERS AND BINS

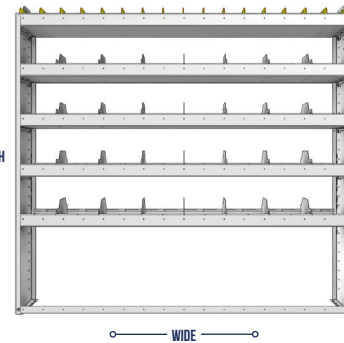
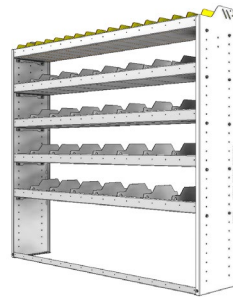
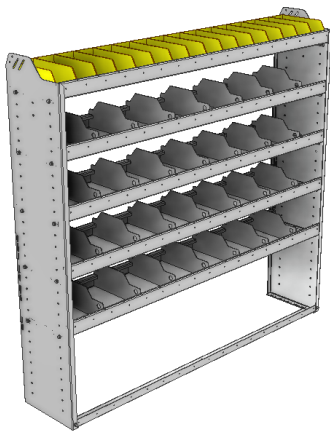
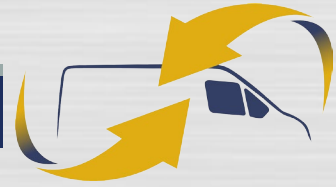

* 18.5 deep combo unit only available with high dividers throughout

PART NUMBER	DEEP (IN.)	WIDE (IN.)	HIGH (IN.)	STD SHELVES	HIGH DIVIDERS	STD BINS	WEIGHT (LBS.)	OPTIONS					
								1 DOOR	BACK PANEL	STD SHELF	6 HIGH DIVIDERS	1 STD BIN	1 STD SHELF LINER
24-6163-4	11.5	69.13	63	4	21	11	84	DO-670	SQB-663	SBS-61	DV-611	SM-BIN	SBL-61
24-6163-5	11.5	69.13	63	5	28	11	99	DO-670	SQB-663	SBS-61	DV-611	SM-BIN	SBL-61
24-6363-4	13.5	69.13	63	4	21	16	101	DO-670	SQB-663	SBS-63	DV-613	MD-BIN	SBL-63
24-6363-5	13.5	69.13	63	5	28	16	118	DO-670	SQB-663	SBS-63	DV-613	MD-BIN	SBL-63
24-6563-4	15.5	69.13	63	4	21	8	113	DO-670	SQB-663	SBS-65	DV-615	LG-BIN	SBL-65
24-6563-5	15.5	69.13	63	5	28	8	131	DO-670	SQB-663	SBS-65	DV-615	LG-BIN	SBL-65
*24-6863-4	18.5	69.13	63	4	28	N / A	118	DO-670	SQB-663	SBS-68	DV-618	N / A	SBL-68
*24-6863-5	18.5	69.13	63	5	35	N / A	139	DO-670	SQB-663	SBS-68	DV-618	N / A	SBL-68

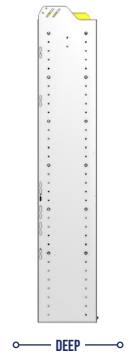
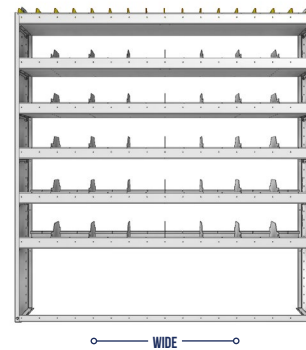
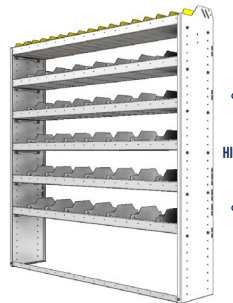
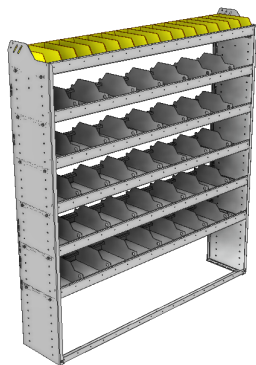

* 18.5 deep combo unit only available with high dividers throughout

PART NUMBER	DEEP (IN.)	WIDE (IN.)	HIGH (IN.)	STD SHELVES	HIGH DIVIDERS	STD BINS	WEIGHT (LBS.)	OPTIONS					
								1 DOOR	BACK PANEL	STD SHELF	6 HIGH DIVIDERS	1 STD BIN	1 STD SHELF LINER
24-6172-5	11.5	69.13	72	5	28	11	101	DO-670	SQB-672	SBS-61	DV-611	SM-BIN	SBL-61
24-6172-6	11.5	69.13	72	6	35	11	116	DO-670	SQB-672	SBS-61	DV-611	SM-BIN	SBL-61
24-6372-5	13.5	69.13	72	5	28	16	120	DO-670	SQB-672	SBS-63	DV-613	MD-BIN	SBL-63
24-6372-6	13.5	69.13	72	6	35	16	137	DO-670	SQB-672	SBS-63	DV-613	MD-BIN	SBL-63
24-6572-5	15.5	69.13	72	5	28	8	134	DO-670	SQB-672	SBS-65	DV-615	LG-BIN	SBL-65
24-6572-6	15.5	69.13	72	6	35	8	153	DO-670	SQB-672	SBS-65	DV-615	LG-BIN	SBL-65
*24-6872-5	18.5	69.13	72	5	35	N / A	143	DO-670	SQB-672	SBS-68	DV-618	N / A	SBL-68
*24-6872-6	18.5	69.13	72	6	42	N / A	164	DO-670	SQB-672	SBS-68	DV-618	N / A	SBL-68

SHELVING UNITS



SQUARE BACK COMBO UNITS / DIVIDERS AND BINS

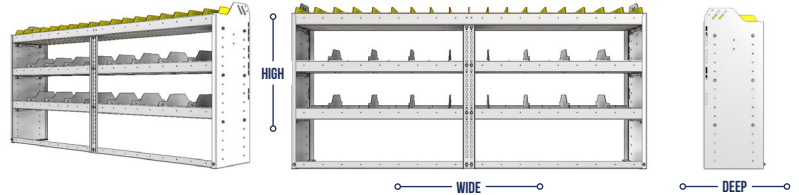
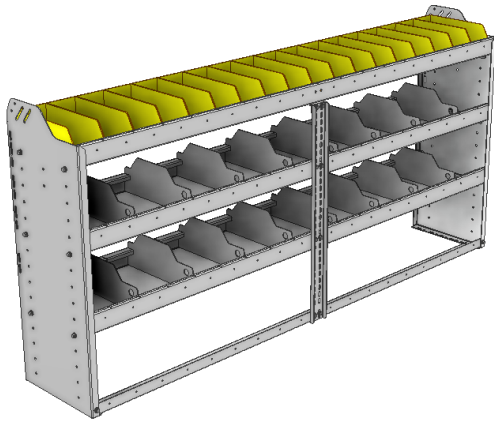

* 18.5 deep combo unit only available with high dividers throughout

PART NUMBER	DEEP (IN.)	WIDE (IN.)	HIGH (IN.)	STD SHELVES	HIGH DIVIDERS	STD BINS	WEIGHT (LBS.)	OPTIONS					
								2 DOOR KIT	BACK PANEL	STD SHELF	6 HIGH DIVIDERS	1 STD BIN	1 STD SHELF LINER
24-7136-3	11.5	77.75	36	3	16	12	70	DO-750	SQB-736	SBS-71	DV-611	SM-BIN	SBL-71
24-7136-4	11.5	77.75	36	4	24	12	86	DO-750	SQB-736	SBS-71	DV-611	SM-BIN	SBL-71
24-7336-3	13.5	77.75	36	3	16	18	84	DO-750	SQB-736	SBS-73	DV-613	MD-BIN	SBL-73
24-7336-4	13.5	77.75	36	4	24	18	104	DO-750	SQB-736	SBS-73	DV-613	MD-BIN	SBL-73
24-7536-3	15.5	77.75	36	3	16	9	95	DO-750	SQB-736	SBS-75	DV-615	LG-BIN	SBL-75
24-7536-4	15.5	77.75	36	4	24	9	116	DO-750	SQB-736	SBS-75	DV-615	LG-BIN	SBL-75
*24-7836-3	18.5	77.75	36	3	24	N / A	95	DO-750	SQB-736	SBS-78	DV-618	N / A	SBL-78
*24-7836-4	18.5	77.75	36	4	32	N / A	119	DO-750	SQB-736	SBS-78	DV-618	N / A	SBL-78

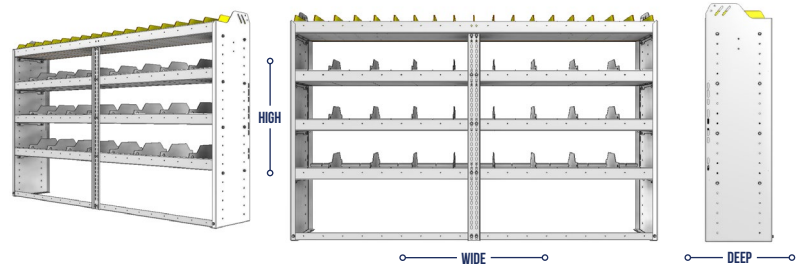
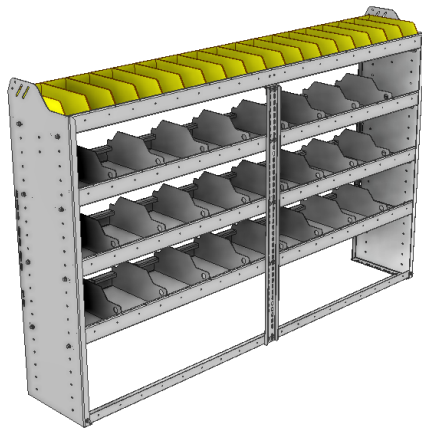

* 18.5 deep combo unit only available with high dividers throughout

PART NUMBER	DEEP (IN.)	WIDE (IN.)	HIGH (IN.)	STD SHELVES	HIGH DIVIDERS	STD BINS	WEIGHT (LBS.)	OPTIONS					
								2 DOOR KIT	BACK PANEL	STD SHELF	6 HIGH DIVIDERS	1 STD BIN	1 STD SHELF LINER
24-7148-3	11.5	77.75	48	3	16	12	73	DO-750	SQB-748	SBS-71	DV-611	SM-BIN	SBL-71
24-7148-4	11.5	77.75	48	4	24	12	90	DO-750	SQB-748	SBS-71	DV-611	SM-BIN	SBL-71
24-7348-3	13.5	77.75	48	3	16	18	88	DO-750	SQB-748	SBS-73	DV-613	MD-BIN	SBL-73
24-7348-4	13.5	77.75	48	4	24	18	107	DO-750	SQB-748	SBS-73	DV-613	MD-BIN	SBL-73
24-7548-3	15.5	77.75	48	3	16	9	99	DO-750	SQB-748	SBS-75	DV-615	LG-BIN	SBL-75
24-7548-4	15.5	77.75	48	4	24	9	120	DO-750	SQB-748	SBS-75	DV-615	LG-BIN	SBL-75
*24-7848-3	18.5	77.75	48	3	24	N / A	100	DO-750	SQB-748	SBS-78	DV-618	N / A	SBL-78
*24-7848-4	18.5	77.75	48	4	32	N / A	125	DO-750	SQB-748	SBS-78	DV-618	N / A	SBL-78

SHELVING UNITS

SQUAREBACK COMBO UNITS / DIVIDERS AND BINS

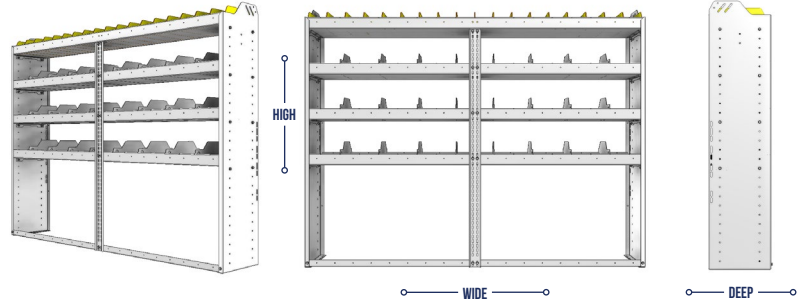
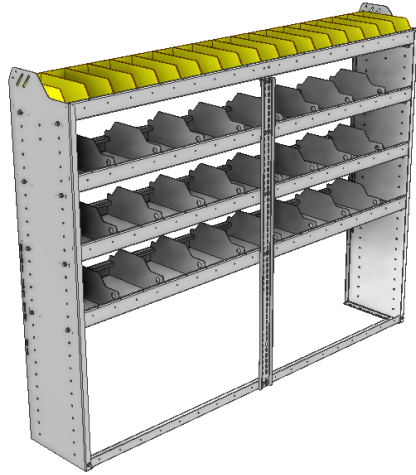
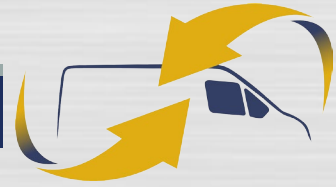

* 18.5 deep combo unit only available with high dividers throughout

PART NUMBER	DEEP (IN.)	WIDE (IN.)	HIGH (IN.)	STD SHELVES	HIGH DIVIDERS	STD BINS	WEIGHT (LBS.)	OPTIONS					
								2 DOOR KIT	BACK PANEL	STD SHELF	6 HIGH DIVIDERS	1 STD BIN	1 STD SHELF LINER
24-7158-3	11.5	77.75	58	3	16	12	76	DO-750	SQB-758	SBS-71	DV-611	SM-BIN	SBL-71
24-7158-4	11.5	77.75	58	4	24	12	93	DO-750	SQB-758	SBS-71	DV-611	SM-BIN	SBL-71
24-7358-3	13.5	77.75	58	3	16	18	91	DO-750	SQB-758	SBS-73	DV-613	MD-BIN	SBL-73
24-7358-4	13.5	77.75	58	4	24	18	111	DO-750	SQB-758	SBS-73	DV-613	MD-BIN	SBL-73
24-7558-3	15.5	77.75	58	3	16	9	103	DO-750	SQB-758	SBS-75	DV-615	LG-BIN	SBL-75
24-7558-4	15.5	77.75	58	4	24	9	124	DO-750	SQB-758	SBS-75	DV-615	LG-BIN	SBL-75
*24-7858-3	18.5	77.75	58	3	24	N/A	104	DO-750	SQB-758	SBS-78	DV-618	N/A	SBL-78
*24-7858-4	18.5	77.75	58	4	32	N/A	129	DO-750	SQB-758	SBS-78	DV-618	N/A	SBL-78

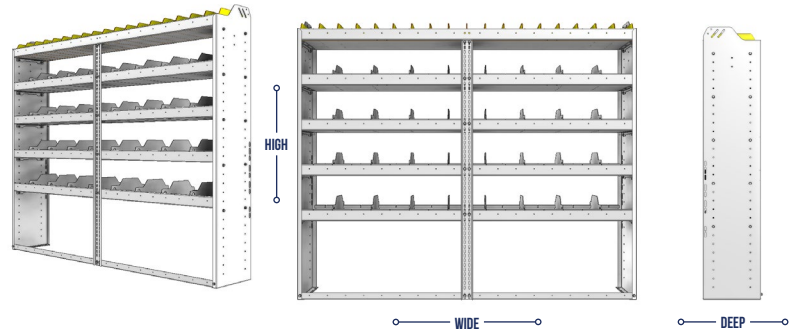
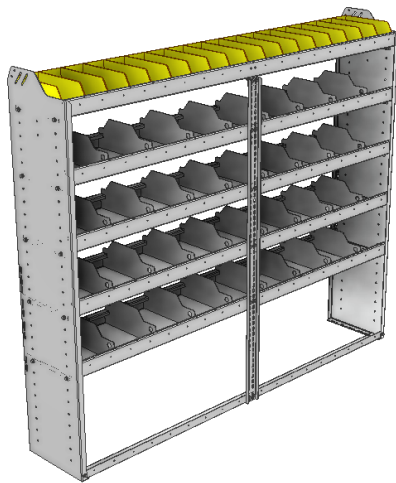

* 18.5 deep combo unit only available with high dividers throughout

PART NUMBER	DEEP (IN.)	WIDE (IN.)	HIGH (IN.)	STD SHELVES	HIGH DIVIDERS	STD BINS	WEIGHT (LBS.)	OPTIONS					
								2 DOOR KIT	BACK PANEL	STD SHELF	6 HIGH DIVIDERS	1 STD BIN	1 STD SHELF LINER
24-7163-4	11.5	77.75	63	4	24	12	94	DO-750	SQB-763	SBS-71	DV-611	SM-BIN	SBL-71
24-7163-5	11.5	77.75	63	5	32	12	111	DO-750	SQB-763	SBS-71	DV-611	SM-BIN	SBL-71
24-7363-4	13.5	77.75	63	4	24	18	112	DO-750	SQB-763	SBS-73	DV-613	MD-BIN	SBL-73
24-7363-5	13.5	77.75	63	5	32	18	132	DO-750	SQB-763	SBS-73	DV-613	MD-BIN	SBL-73
24-7563-4	15.5	77.75	63	4	24	9	126	DO-750	SQB-763	SBS-75	DV-615	LG-BIN	SBL-75
24-7563-5	15.5	77.75	63	5	32	9	147	DO-750	SQB-763	SBS-75	DV-615	LG-BIN	SBL-75
*24-7863-4	18.5	77.75	63	4	32	N/A	131	DO-750	SQB-763	SBS-78	DV-618	N/A	SBL-78
*24-7863-5	18.5	77.75	63	5	40	N/A	155	DO-750	SQB-763	SBS-78	DV-618	N/A	SBL-78

SHELVING UNITS

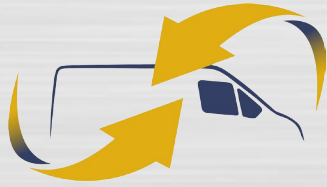

SQUARE BACK COMBO UNITS / DIVIDERS AND BINS

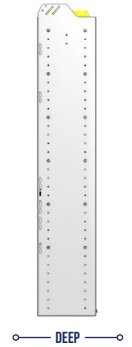
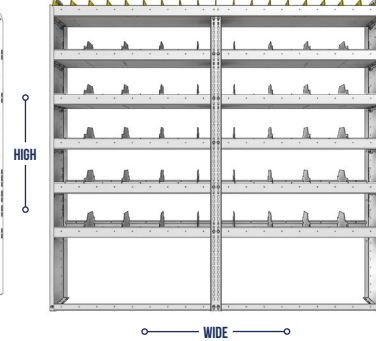
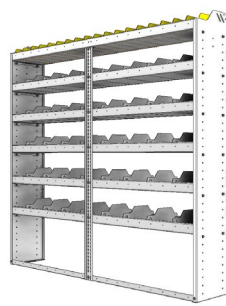
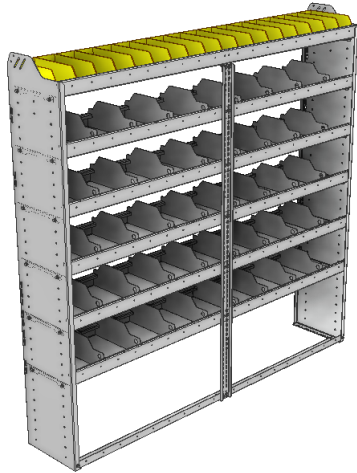

* 18.5 deep combo unit only available with high dividers throughout

PART NUMBER	DEEP (IN.)	WIDE (IN.)	HIGH (IN.)	STD SHELVES	HIGH DIVIDERS	STD BINS	WEIGHT (LBS.)	OPTIONS					
								2 DOOR KIT	BACK PANEL	STD SHELF	6 HIGH DIVIDERS	1 STD BIN	1 STD SHELF LINER
24-7172-5	11.5	77.75	72	5	32	12	113	DO-750	SQB-772	SBS-71	DV-611	SM-BIN	SBL-71
24-7172-6	11.5	77.75	72	6	40	12	130	DO-750	SQB-772	SBS-71	DV-611	SM-BIN	SBL-71
24-7372-5	13.5	77.75	72	5	32	18	134	DO-750	SQB-772	SBS-73	DV-613	MD-BIN	SBL-73
24-7372-6	13.5	77.75	72	6	40	18	154	DO-750	SQB-772	SBS-73	DV-613	MD-BIN	SBL-73
24-7572-5	15.5	77.75	72	5	32	9	150	DO-750	SQB-772	SBS-75	DV-615	LG-BIN	SBL-75
24-7572-6	15.5	77.75	72	6	40	9	171	DO-750	SQB-772	SBS-75	DV-615	LG-BIN	SBL-75
*24-7872-5	18.5	77.75	72	5	40	N/A	159	DO-750	SQB-772	SBS-78	DV-618	N/A	SBL-78
*24-7872-6	18.5	77.75	72	6	48	N/A	183	DO-750	SQB-772	SBS-78	DV-618	N/A	SBL-78

SHELVING UNITS

SQUAREBACK COMBO UNITS / DIVIDERS AND BINS

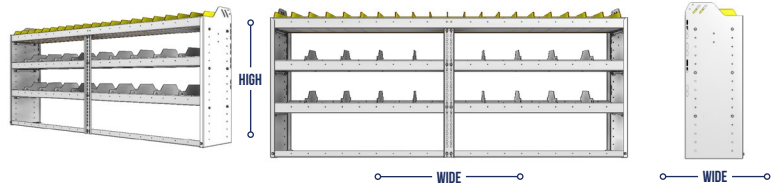
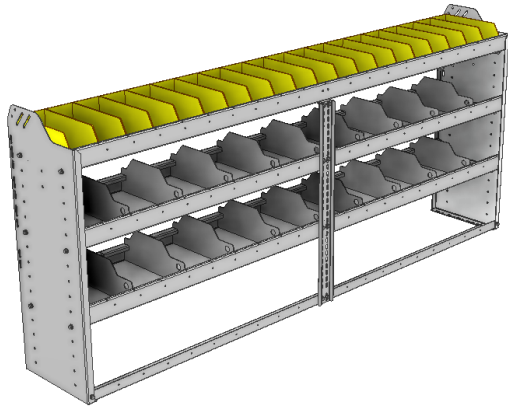

*18.5 deep combo unit only available with high dividers throughout

PART NUMBER	DEEP (IN.)	WIDE (IN.)	HIGH (IN.)	STD SHELVES	HIGH DIVIDERS	STD BINS	WEIGHT (LBS.)	OPTIONS					
								2 DOOR KIT	BACK PANEL	STD SHELF	6 HIGH DIVIDERS	1 STD BIN	1 STD SHELF LINER
24-8136-3	11.5	86.38	36	3	18	14	77	DO-840	SQB-836	SBS-81	DV-611	SM-BIN	SBL-81
24-8136-4	11.5	86.38	36	4	27	14	95	DO-840	SQB-836	SBS-81	DV-611	SM-BIN	SBL-81
24-8336-3	13.5	86.38	36	3	18	20	92	DO-840	SQB-836	SBS-83	DV-613	MD-BIN	SBL-83
24-8336-4	13.5	86.38	36	4	27	20	114	DO-840	SQB-836	SBS-83	DV-613	MD-BIN	SBL-83
24-8536-3	15.5	86.38	36	3	18	10	104	DO-840	SQB-836	SBS-85	DV-615	LG-BIN	SBL-85
24-8536-4	15.5	86.38	36	4	27	10	127	DO-840	SQB-836	SBS-85	DV-615	LG-BIN	SBL-85
*24-8836-3	18.5	86.38	36	3	27	N/A	104	DO-840	SQB-836	SBS-88	DV-618	N/A	SBL-88
*24-8836-4	18.5	86.38	36	4	36	N/A	131	DO-840	SQB-836	SBS-88	DV-618	N/A	SBL-88

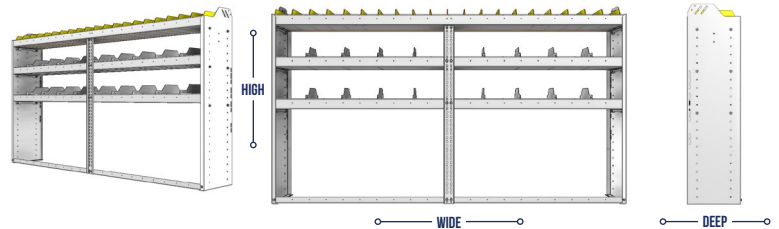
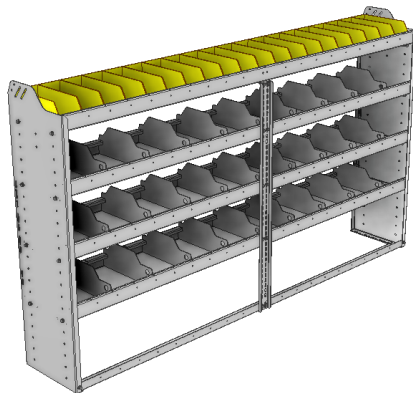

*18.5 deep combo unit only available with high dividers throughout

PART NUMBER	DEEP (IN.)	WIDE (IN.)	HIGH (IN.)	STD SHELVES	HIGH DIVIDERS	STD BINS	WEIGHT (LBS.)	OPTIONS					
								2 DOOR KIT	BACK PANEL	STD SHELF	6 HIGH DIVIDERS	1 STD BIN	1 STD SHELF LINER
24-8148-3	11.5	86.38	48	3	18	14	80	DO-840	SQB-848	SBS-81	DV-611	SM-BIN	SBL-81
24-8148-4	11.5	86.38	48	4	27	14	99	DO-840	SQB-848	SBS-81	DV-611	SM-BIN	SBL-81
24-8348-3	13.5	86.38	48	3	18	20	96	DO-840	SQB-848	SBS-83	DV-613	MD-BIN	SBL-83
24-8348-4	13.5	86.38	48	4	27	20	118	DO-840	SQB-848	SBS-83	DV-613	MD-BIN	SBL-83
24-8548-3	15.5	86.38	48	3	18	10	108	DO-840	SQB-848	SBS-85	DV-615	LG-BIN	SBL-85
24-8548-4	15.5	86.38	48	4	27	10	132	DO-840	SQB-848	SBS-85	DV-615	LG-BIN	SBL-85
*24-8848-3	18.5	86.38	48	3	27	N/A	109	DO-840	SQB-848	SBS-88	DV-618	N/A	SBL-88
*24-8848-4	18.5	86.38	48	4	36	N/A	136	DO-840	SQB-848	SBS-88	DV-618	N/A	SBL-88

SHELVING UNITS

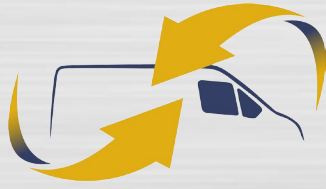

SQUARE BACK COMBO UNITS / DIVIDERS AND BINS

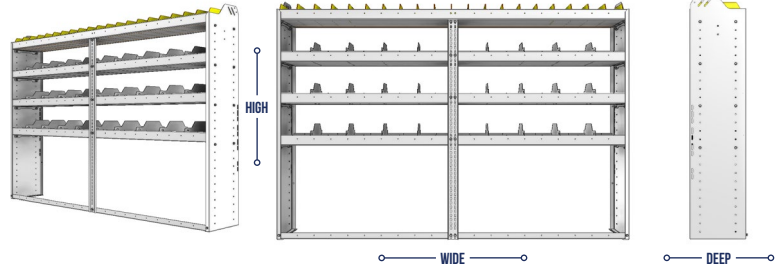

* 18.5 deep combo unit only available with high dividers throughout

PART NUMBER	DEEP (IN.)	WIDE (IN.)	HIGH (IN.)	STD SHELVES	HIGH DIVIDERS	STD BINS	WEIGHT (LBS.)	OPTIONS					
								2 DOOR KIT	BACK PANEL	STD SHELF	6 HIGH DIVIDERS	1 STD BIN	1 STD SHELF LINER
24-8158-3	11.5	86.38	58	3	18	14	83	DO-840	SQB-858	SBS-81	DV-611	SM-BIN	SBL-81
24-8158-4	11.5	86.38	58	4	27	14	101	DO-840	SQB-858	SBS-81	DV-611	SM-BIN	SBL-81
24-8358-3	13.5	86.38	58	3	18	20	99	DO-840	SQB-858	SBS-83	DV-613	MD-BIN	SBL-83
24-8358-4	13.5	86.38	58	4	27	20	121	DO-840	SQB-858	SBS-83	DV-613	MD-BIN	SBL-83
24-8558-3	15.5	86.38	58	3	18	10	112	DO-840	SQB-858	SBS-85	DV-615	LG-BIN	SBL-85
24-8558-4	15.5	86.38	58	4	27	10	135	DO-840	SQB-858	SBS-85	DV-615	LG-BIN	SBL-85
*24-8858-3	18.5	86.38	58	3	27	N / A	113	DO-840	SQB-858	SBS-88	DV-618	N / A	SBL-88
*24-8858-4	18.5	86.38	58	4	36	N / A	141	DO-840	SQB-858	SBS-88	DV-618	N / A	SBL-88

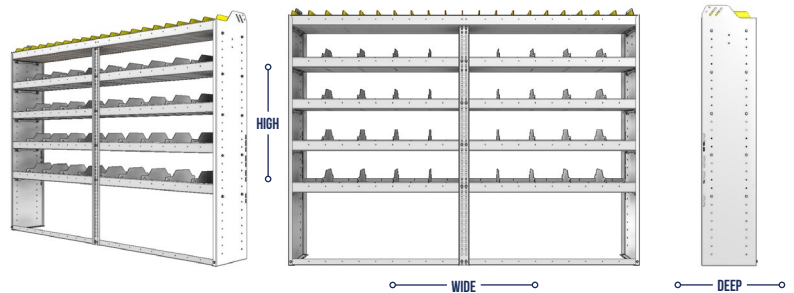
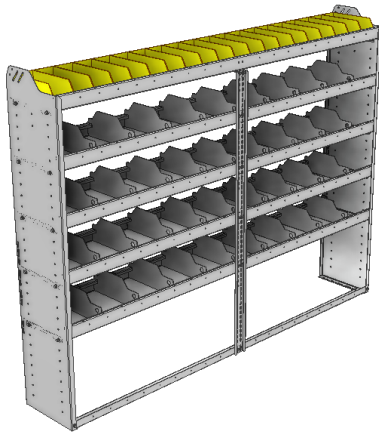

* 18.5 deep combo unit only available with high dividers throughout

PART NUMBER	DEEP (IN.)	WIDE (IN.)	HIGH (IN.)	STD SHELVES	HIGH DIVIDERS	STD BINS	WEIGHT (LBS.)	OPTIONS					
								2 DOOR KIT	BACK PANEL	STD SHELF	6 HIGH DIVIDERS	1 STD BIN	1 STD SHELF LINER
24-8163-4	11.5	86.38	63	4	27	14	103	DO-840	SQB-863	SBS-81	DV-611	SM-BIN	SBL-81
24-8163-5	11.5	86.38	63	5	36	14	121	DO-840	SQB-863	SBS-81	DV-611	SM-BIN	SBL-81
24-8363-4	13.5	86.38	63	4	27	20	123	DO-840	SQB-863	SBS-83	DV-613	MD-BIN	SBL-83
24-8363-5	13.5	86.38	63	5	36	20	144	DO-840	SQB-863	SBS-83	DV-613	MD-BIN	SBL-83
24-8563-4	15.5	86.38	63	4	27	10	137	DO-840	SQB-863	SBS-85	DV-615	LG-BIN	SBL-85
24-8563-5	15.5	86.38	63	5	36	10	161	DO-840	SQB-863	SBS-85	DV-615	LG-BIN	SBL-85
*24-8863-4	18.5	86.38	63	4	36	N / A	143	DO-840	SQB-863	SBS-88	DV-618	N / A	SBL-88
*24-8863-5	18.5	86.38	63	5	45	N / A	170	DO-840	SQB-863	SBS-88	DV-618	N / A	SBL-88

SHELVING UNITS

SQUAREBACK COMBO UNITS / DIVIDERS AND BINS

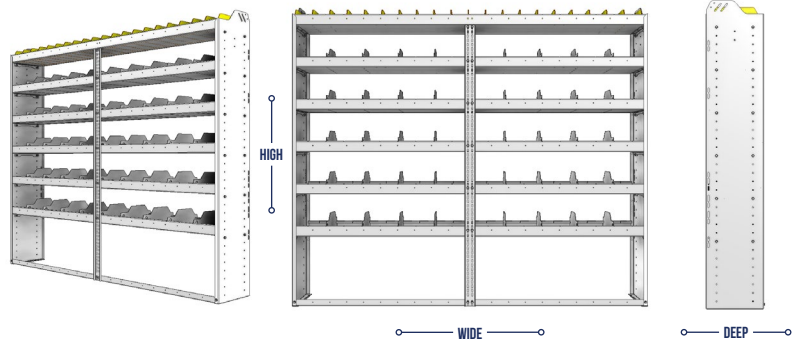
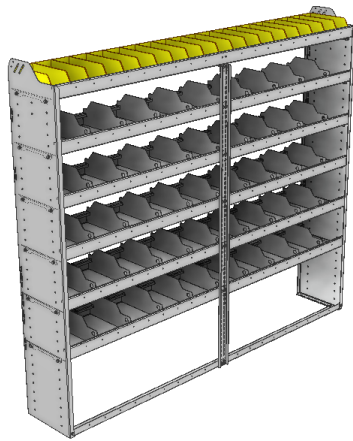
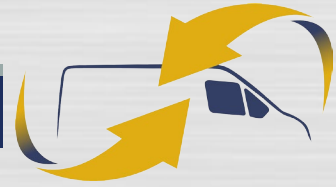

* 18.5 deep combo unit only available with high dividers throughout

PART NUMBER	DEEP (IN.)	WIDE (IN.)	HIGH (IN.)	STD SHELVES	HIGH DIVIDERS	STD BINS	WEIGHT (LBS.)	OPTIONS					
								2 DOOR KIT	BACK PANEL	STD SHELF	6 HIGH DIVIDERS	1 STD BIN	1 STD SHELF LINER
24-8172-5	11.5	86.38	72	5	36	14	124	DO-840	SQB-872	SBS-81	DV-611	SM-BIN	SBL-81
24-8172-6	11.5	86.38	72	6	45	14	142	DO-840	SQB-872	SBS-81	DV-611	SM-BIN	SBL-81
24-8372-5	13.5	86.38	72	5	36	20	147	DO-840	SQB-872	SBS-83	DV-613	MD-BIN	SBL-83
24-8372-6	13.5	86.38	72	6	45	20	168	DO-840	SQB-872	SBS-83	DV-613	MD-BIN	SBL-83
24-8572-5	15.5	86.38	72	5	36	10	164	DO-840	SQB-872	SBS-85	DV-615	LG-BIN	SBL-85
24-8572-6	15.5	86.38	72	6	45	10	187	DO-840	SQB-872	SBS-85	DV-615	LG-BIN	SBL-85
*24-8872-5	18.5	86.38	72	5	45	N / A	174	DO-840	SQB-872	SBS-88	DV-618	N / A	SBL-88
*24-8872-6	18.5	86.38	72	6	54	N / A	201	DO-840	SQB-872	SBS-88	DV-618	N / A	SBL-88

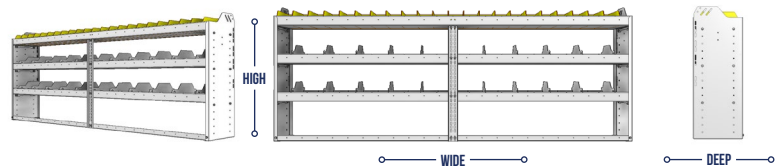
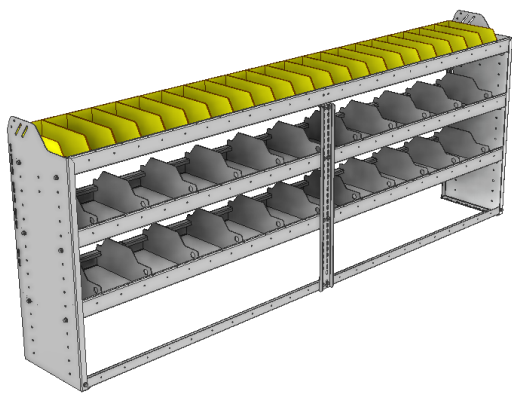

* 18.5 deep combo unit only available with high dividers throughout

PART NUMBER	DEEP (IN.)	WIDE (IN.)	HIGH (IN.)	STD SHELVES	HIGH DIVIDERS	STD BINS	WEIGHT (LBS.)	OPTIONS					
								2 DOOR KIT	BACK PANEL	STD SHELF	6 HIGH DIVIDERS	1 STD BIN	1 STD SHELF LINER
24-9136-3	11.5	95	36	3	22	15	84	DO-940	SQB-936	SBS-91	DV-611	SM-BIN	SBL-91
24-9136-4	11.5	95	36	4	33	15	105	DO-940	SQB-936	SBS-91	DV-611	SM-BIN	SBL-91
24-9336-3	13.5	95	36	3	22	22	102	DO-940	SQB-936	SBS-93	DV-613	MD-BIN	SBL-93
24-9336-4	13.5	95	36	4	33	22	127	DO-940	SQB-936	SBS-93	DV-613	MD-BIN	SBL-93
24-9536-3	15.5	95	36	3	22	11	115	DO-940	SQB-936	SBS-95	DV-615	LG-BIN	SBL-95
24-9536-4	15.5	95	36	4	33	11	142	DO-940	SQB-936	SBS-95	DV-615	LG-BIN	SBL-95
*24-9836-3	18.5	95	36	3	33	N / A	116	DO-940	SQB-936	SBS-98	DV-618	N / A	SBL-98
*24-9836-4	18.5	95	36	4	44	N / A	147	DO-940	SQB-936	SBS-98	DV-618	N / A	SBL-98

SHELVING UNITS

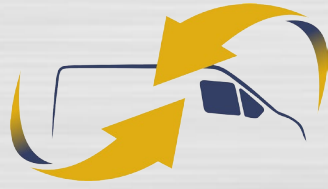

SQUARE BACK COMBO UNITS / DIVIDERS AND BINS

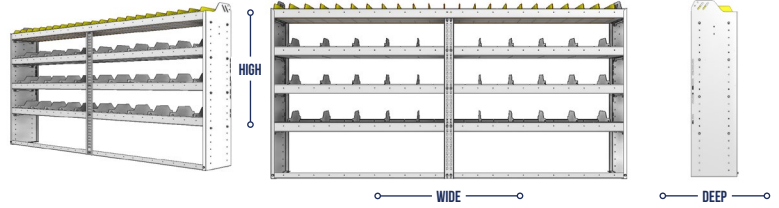
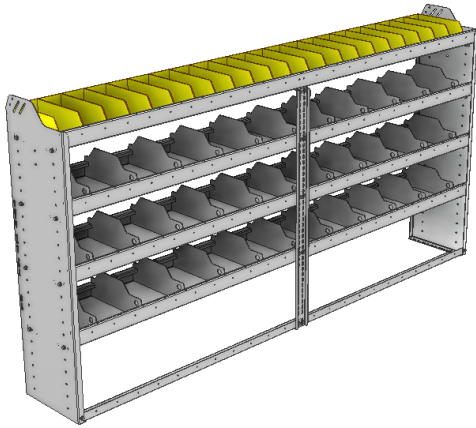

* 18.5 deep combo unit only available with high dividers throughout

PART NUMBER	DEEP (IN.)	WIDE (IN.)	HIGH (IN.)	STD SHELVES	HIGH DIVIDERS	STD BINS	WEIGHT (LBS.)	OPTIONS					
								2 DOOR KIT	BACK PANEL	STD SHELF	6 HIGH DIVIDERS	1 STD BIN	1 STD SHELF LINER
24-9148-3	11.5	95	48	3	22	15	88	DO-940	SQB-948	SBS-91	DV-611	SM-BIN	SBL-91
24-9148-4	11.5	95	48	4	33	15	109	DO-940	SQB-948	SBS-91	DV-611	SM-BIN	SBL-91
24-9348-3	13.5	95	48	3	22	22	106	DO-940	SQB-948	SBS-93	DV-613	MD-BIN	SBL-93
24-9348-4	13.5	95	48	4	33	22	130	DO-940	SQB-948	SBS-93	DV-613	MD-BIN	SBL-93
24-9548-3	15.5	95	48	3	22	11	119	DO-940	SQB-948	SBS-95	DV-615	LG-BIN	SBL-95
24-9548-4	15.5	95	48	4	33	11	146	DO-940	SQB-948	SBS-95	DV-615	LG-BIN	SBL-95
*24-9848-3	18.5	95	48	3	33	N / A	121	DO-940	SQB-948	SBS-98	DV-618	N / A	SBL-98
*24-9848-4	18.5	95	48	4	44	N / A	152	DO-940	SQB-948	SBS-98	DV-618	N / A	SBL-98

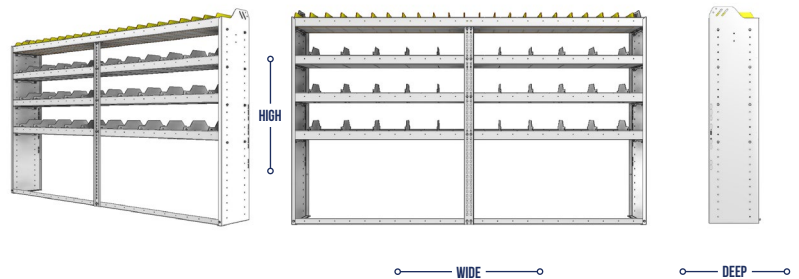

* 18.5 deep combo unit only available with high dividers throughout

PART NUMBER	DEEP (IN.)	WIDE (IN.)	HIGH (IN.)	STD SHELVES	HIGH DIVIDERS	STD BINS	WEIGHT (LBS.)	OPTIONS					
								2 DOOR KIT	BACK PANEL	STD SHELF	6 HIGH DIVIDERS	1 STD BIN	1 STD SHELF LINER
24-9158-3	11.5	95	58	3	22	15	91	DO-940	SQB-958	SBS-91	DV-611	SM-BIN	SBL-91
24-9158-4	11.5	95	58	4	33	15	112	DO-940	SQB-958	SBS-91	DV-611	SM-BIN	SBL-91
24-9358-3	13.5	95	58	3	22	22	109	DO-940	SQB-958	SBS-93	DV-613	MD-BIN	SBL-93
24-9358-4	13.5	95	58	4	33	22	134	DO-940	SQB-958	SBS-93	DV-613	MD-BIN	SBL-93
24-9558-3	15.5	95	58	3	22	11	123	DO-940	SQB-958	SBS-95	DV-615	LG-BIN	SBL-95
24-9558-4	15.5	95	58	4	33	11	150	DO-940	SQB-958	SBS-95	DV-615	LG-BIN	SBL-95
*24-9858-3	18.5	95	58	3	33	N / A	126	DO-940	SQB-958	SBS-98	DV-618	N / A	SBL-98
*24-9858-4	18.5	95	58	4	44	N / A	157	DO-940	SQB-958	SBS-98	DV-618	N / A	SBL-98

SHELVING UNITS

SQUAREBACK COMBO UNITS / DIVIDERS AND BINS

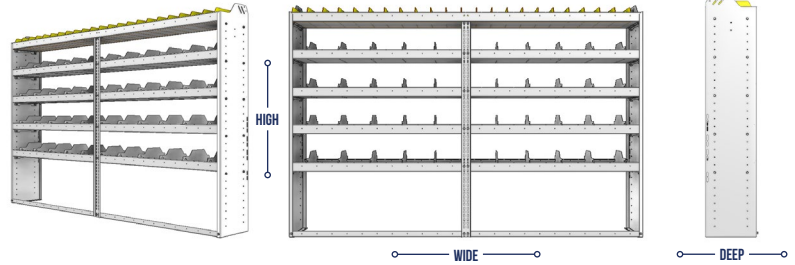
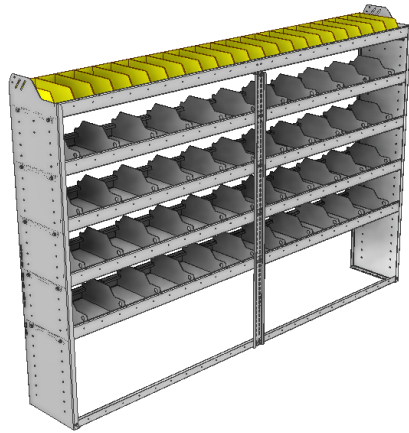
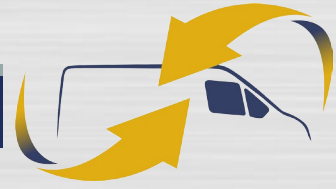

* 18.5 deep combo unit only available with high dividers throughout

PART NUMBER	DEEP (IN.)	WIDE (IN.)	HIGH (IN.)	STD SHELVES	HIGH DIVIDERS	STD BINS	WEIGHT (LBS.)	OPTIONS					
								2 DOOR KIT	BACK PANEL	STD SHELF	6 HIGH DIVIDERS	1 STD BIN	1 STD SHELF LINER
24-9163-4	11.5	95	63	4	33	15	113	DO-940	SQB-963	SBS-91	DV-611	SM-BIN	SBL-91
24-9163-5	11.5	95	63	5	44	15	134	DO-940	SQB-963	SBS-91	DV-611	SM-BIN	SBL-91
24-9363-4	13.5	95	63	4	33	22	135	DO-940	SQB-963	SBS-93	DV-613	MD-BIN	SBL-93
24-9363-5	13.5	95	63	5	44	22	160	DO-940	SQB-963	SBS-93	DV-613	MD-BIN	SBL-93
24-9563-4	15.5	95	63	4	33	11	151	DO-940	SQB-963	SBS-95	DV-615	LG-BIN	SBL-95
24-9563-5	15.5	95	63	5	44	11	178	DO-940	SQB-963	SBS-95	DV-615	LG-BIN	SBL-95
*24-9863-4	18.5	95	63	4	44	N / A	159	DO-940	SQB-963	SBS-98	DV-618	N / A	SBL-98
*24-9863-5	18.5	95	63	5	55	N / A	190	DO-940	SQB-963	SBS-98	DV-618	N / A	SBL-98

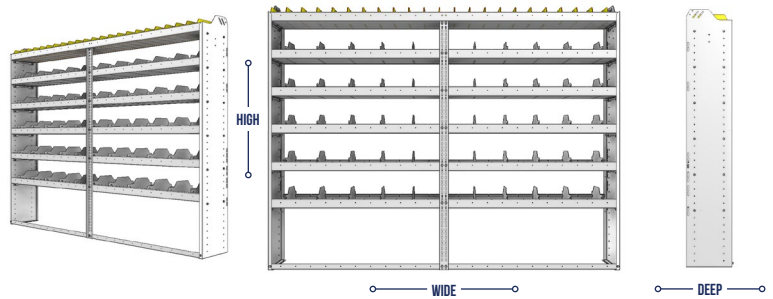
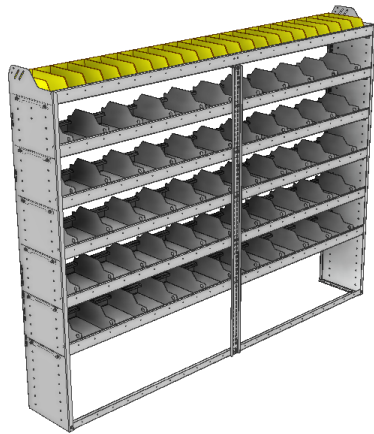

* 18.5 deep combo unit only available with high dividers throughout

PART NUMBER	DEEP (IN.)	WIDE (IN.)	HIGH (IN.)	STD SHELVES	HIGH DIVIDERS	STD BINS	WEIGHT (LBS.)	OPTIONS					
								2 DOOR KIT	BACK PANEL	STD SHELF	6 HIGH DIVIDERS	1 STD BIN	1 STD SHELF LINER
24-9172-5	11.5	95	72	5	44	15	137	DO-940	SQB-972	SBS-91	DV-611	SM-BIN	SBL-91
24-9172-6	11.5	95	72	6	55	15	158	DO-940	SQB-972	SBS-91	DV-611	SM-BIN	SBL-91
24-9372-5	13.5	95	72	5	44	22	163	DO-940	SQB-972	SBS-93	DV-613	MD-BIN	SBL-93
24-9372-6	13.5	95	72	6	55	22	187	DO-940	SQB-972	SBS-93	DV-613	MD-BIN	SBL-93
24-9572-5	15.5	95	72	5	44	11	181	DO-940	SQB-972	SBS-95	DV-615	LG-BIN	SBL-95
24-9572-6	15.5	95	72	6	55	11	208	DO-940	SQB-972	SBS-95	DV-615	LG-BIN	SBL-95
*24-9872-5	18.5	95	72	5	55	N / A	194	DO-940	SQB-972	SBS-98	DV-618	N / A	SBL-98
*24-9872-6	18.5	95	72	6	66	N / A	225	DO-940	SQB-972	SBS-98	DV-618	N / A	SBL-98